

REVISIONS			
LTR	DESCRIPTION	DATE	APPVD

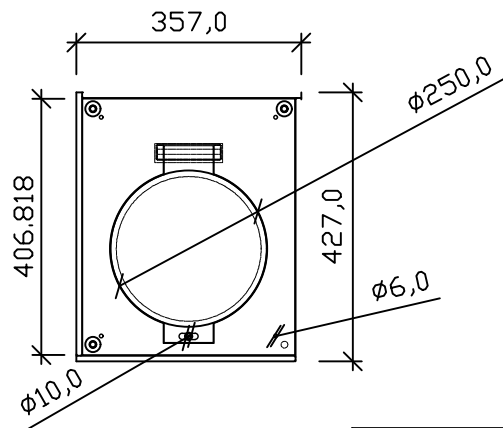
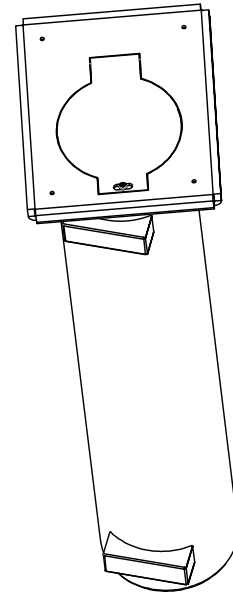
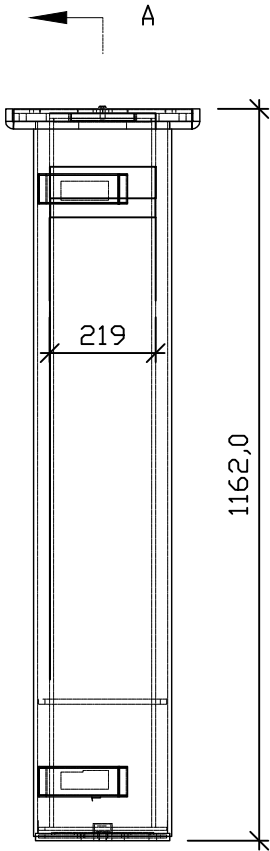
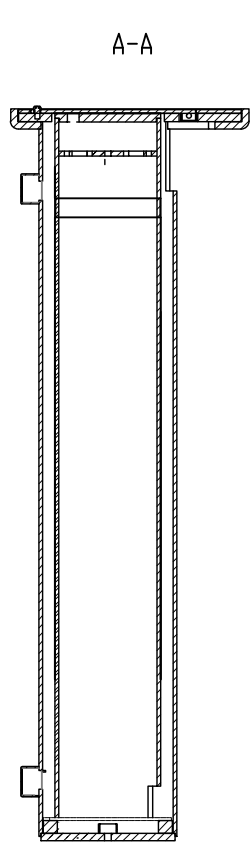

APPLICATION	
NEXT ASSY	USED ON

SERIES NUMBER:		CAGE CODE	SIZE	DRAWING NUMBER:
PRODUCT FAMILY:	FIXED BOLLARD	6NQJB		8" LID SEMI AUTO
PRODUCT CLASS:	STANDARD OR CUSTOMER DEFINED	DRAWN BY:	MJW	DRAWING REV:
PRODUCT LINE:	BOLLARD	CHECKED BY:		SHEET: 1 OF 1
PRODUCT SUB LINE:	SEMI AUTO	APPROVED BY:		RELEASE DATE:
1-800-BOLLARDS, Inc. 24370 Northwestern Hwy, Suite 250 Southfield, MI. 48075				TITLE:
PHONE: 1-800-BOLLARDS				BOLLARD, SEMI AUTO
WEB: WWW.1800BOLLARDS.COM				
EMAIL: INFO@1800BOLLARDS.COM				