









1-800-BOLLARDS

The Bollard Experts

- SELECT DESIRED MATERIAL: (6" NOMINAL SIZE)
 - FCST06040 SCH 40 STAINLESS STEEL
 - FCST06040 SCH 40 ASTM A-53 CARBON STEEL
- SELECT DESIRED STAINLESS STEEL BOLLARD FINISH:
 - POLISHED #4 FINISH
 - AS SPECIFIED _____
- SELECT DESIRED CARBON STEEL BOLLARD FINISH:
 - POWDERCOAL RAL # _____
 - AS SPECIFIED _____
- SELECT DESIRED STAINLESS STEEL BOLLARD MATERIAL:
 - TYPE 304
 - TYPE 316
- SELECT DESIRED BOLLARD CAP STYLE:
 -  DOME (SHOWN)
 -  STANDARD FLAT
 -  SLOPED
- LENS SELECTION
 - CLEAR 
 - FROSTED 
 - INTERNAL FROSTED 
 - PARACLINE 
 - LOUVER 
- WATTAGE
 - 5W 16LEDS 100mA
 - 8W 16LEDS 175mA
 - 12W 16LEDS 250mA
- CCT
 - COOL
 - NEUTRAL
 - WARM
- VOLTAGE
 - 120-277VAC
 - 120V

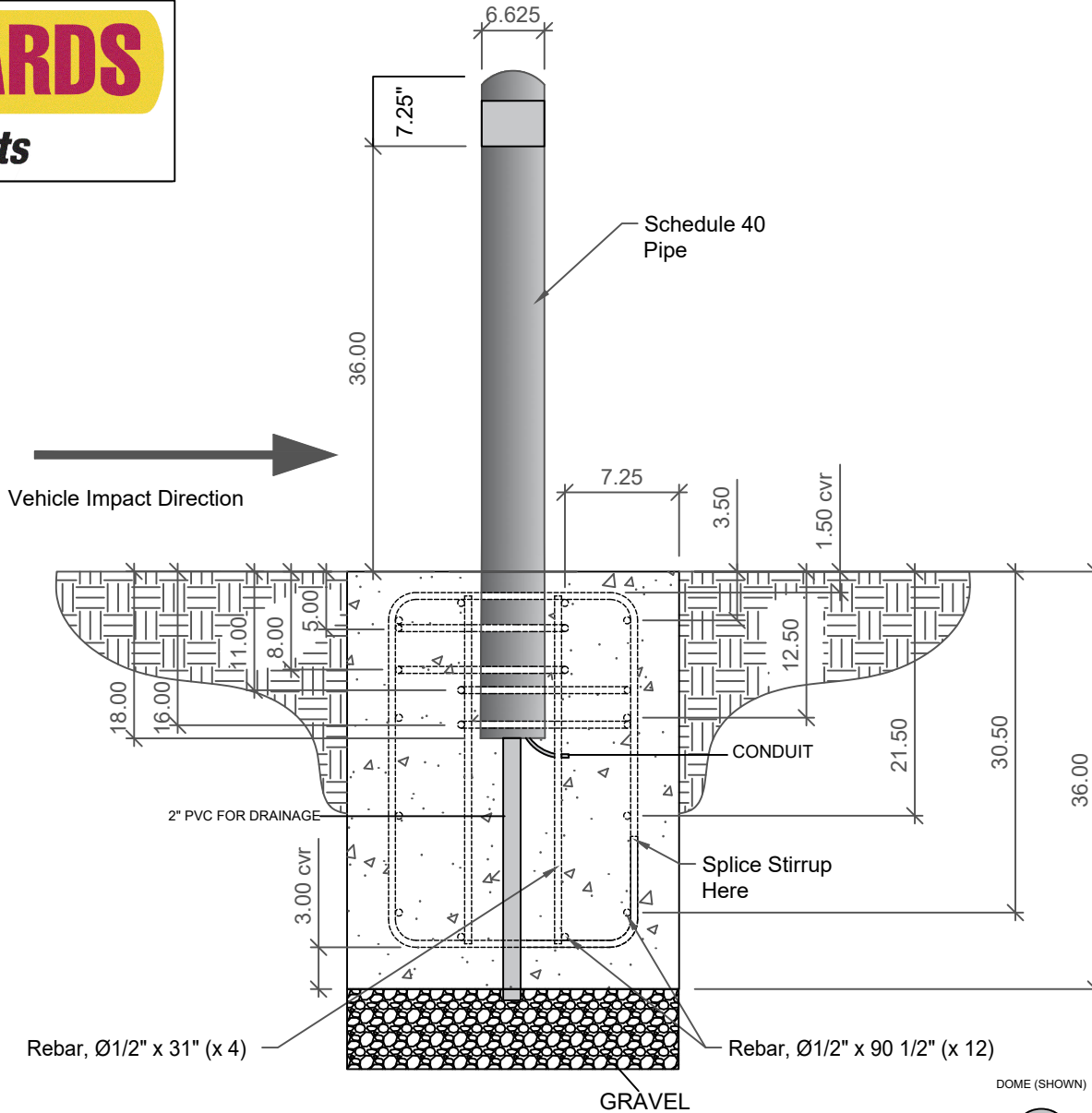

REVISIONS			
LTR	DESCRIPTION	DATE	APPVD

COMMENTS			

SPECIFICATIONS			
HEIGHT: 36"			
DIAMETER: 6.625"			
WALL THICKNESS: 0.280"			

END VIEW-FOUNDATION

DOME (SHOWN) STANDARD FLAT SLOPED



APPLICATION		SERIES NUMBER: XX-S060-XX		CAGE CODE: 6NGJB		REV: 6" CT FIXED	
NEXT ASSY	USED ON	PRODUCT FAMILY: 20 MPH CRASH TESTED	PRODUCT CLASS: STANDARD OR CUSTOMER DEFINED	PRODUCT LINE: BOLLARD	PRODUCT SUB LINE: FIXED	DRAWN BY: AJA	DRAWING REV: 1
						CHECKED BY:	SHEET: 1 OF 1
						APPROVED BY:	RELEASE DATE:
		1-800-BOLLARDS, Inc. 10 Hughes Suite A105 Irvine, CA 92618 PHONE: 1-800-BOLLARDS WEB: WWW.1800BOLLARDS.COM EMAIL: INFO@1800BOLLARDS.COM		BOLLARD, CT FIXED			

1. THIS DRAWING IS TO BE COMPLETED IN ACCORDANCE WITH MANUFACTURER'S SPECIFICATIONS.
2. DO NOT SCALE DRAWING.
3. THIS DRAWING IS INTENDED FOR USE BY ARCHITECTS, ENGINEERS, CONTRACTORS, GENERALISTS AND DESIGN PROFESSIONALS FOR PLANNING PURPOSES ONLY. THIS DRAWING IS NOT TO BE USED FOR CONSTRUCTION.
4. ALL INFORMATION CONTAINED HEREIN WAS CURRENT AT THE TIME OF DEVELOPMENT BUT MUST BE REVIEWED AND APPROVED BY THE PRODUCT MANUFACTURER TO BE CONSIDERED ACCURATE.

1-800-BOLLARDS

The Bollard Experts

- SELECT DESIRED MATERIAL: (6" NOMINAL SIZE)
 - FCST06040 SCH 40 STAINLESS STEEL
 - FCST06040 SCH 40 ASTM A-53 CARBON STEEL
- SELECT DESIRED STAINLESS STEEL BOLLARD FINISH:
 - POLISHED #4 FINISH
 - AS SPECIFIED _____
- SELECT DESIRED CARBON STEEL BOLLARD FINISH:
 - POWDERCOAL RAL # _____
 - AS SPECIFIED _____
- SELECT DESIRED STAINLESS STEEL BOLLARD MATERIAL:
 - TYPE 304
 - TYPE 316
- SELECT DESIRED BOLLARD CAP STYLE:
 - DOME (SHOWN)
 - STANDARD FLAT
 - SLOPED
- LENS SELECTION
 - CLEAR
 - FROSTED
 - INTERNAL FROSTED
 - PARACLINE SILVER
 - PARACLINE WHITE
 - LOUVER GREY
 - LOUVER WHITE
- WATTAGE
 - 5W 16LEDS 100mA
 - 8W 16LEDS 175mA
 - 12W 16LEDS 250mA
- CCT
 - COOL
 - NEUTRAL
 - WARM
- VOLTAGE
 - 120-277VAC
 - 120V

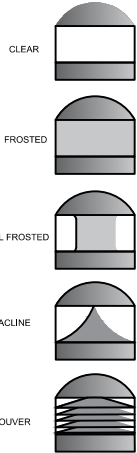

REVISIONS			
LTR	DESCRIPTION	DATE	APP
COMMENTS			

SPECIFICATIONS

HEIGHT: 36"
 DIAMETER: 6.625"
 WALL THICKNESS: 0.280"

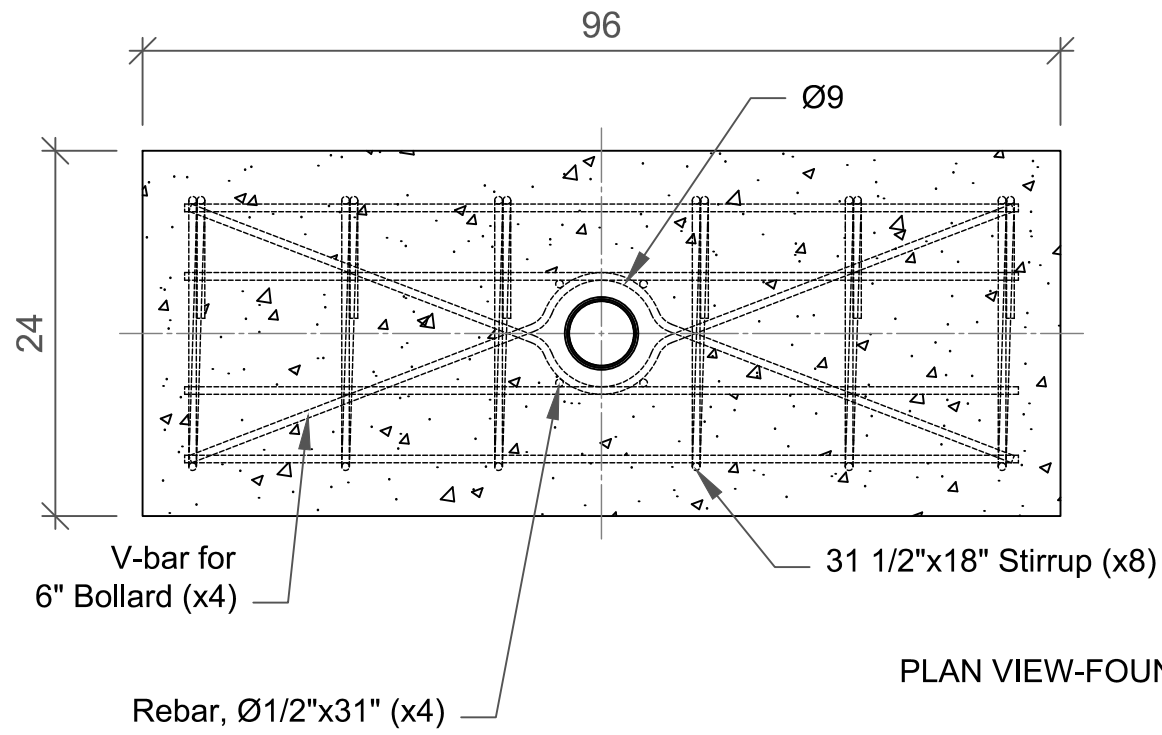

PLAN VIEW-FOUNDATION

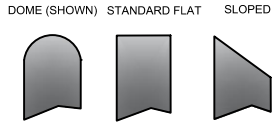











APPLICATION		1-800-BOLLARDS, Inc. 10 Hughes Suite A100 Irvine, CA 92618 PHONE: 1-800-BOLLARDS WEB: WWW.1800BOLLARDS.COM EMAIL: INFO@1800BOLLARDS.COM	TITLE: BOLLARD, CT FIXED
NEXT ASBY	USED IN		
SERIES NUMBER: XX-S060-XX	SIZE CODE: 8" CT FIXED	USE: GNGJIB	DRAWING NUMBER: 8" CT FIXED
PRODUCT FAMILY: 20 MPH CRASH TESTED	PRODUCT CLASS: STANDARD OR CUSTOMER DEFINED	DRAWN BY: AJA	DRAWING REV: SHEET 1 OF 1
PRODUCT LINE: BOLLARD	CREATED BY:	APPROVED BY:	RELEASE DATE:
PRODUCT SUB LINE: FIXED			

1. THIS DRAWING IS TO BE COMPLETED IN ACCORDANCE WITH MANUFACTURER'S SPECIFICATIONS.
 2. THE USER SHALL BE RESPONSIBLE FOR OBTAINING ALL NECESSARY PERMITS AND APPROVALS.
 3. THE USER SHALL BE RESPONSIBLE FOR OBTAINING ALL NECESSARY PERMITS AND APPROVALS.
 4. THE USER SHALL BE RESPONSIBLE FOR OBTAINING ALL NECESSARY PERMITS AND APPROVALS.
 5. THE USER SHALL BE RESPONSIBLE FOR OBTAINING ALL NECESSARY PERMITS AND APPROVALS.
 6. THE USER SHALL BE RESPONSIBLE FOR OBTAINING ALL NECESSARY PERMITS AND APPROVALS.
 7. THE USER SHALL BE RESPONSIBLE FOR OBTAINING ALL NECESSARY PERMITS AND APPROVALS.
 8. THE USER SHALL BE RESPONSIBLE FOR OBTAINING ALL NECESSARY PERMITS AND APPROVALS.
 9. THE USER SHALL BE RESPONSIBLE FOR OBTAINING ALL NECESSARY PERMITS AND APPROVALS.
 10. THE USER SHALL BE RESPONSIBLE FOR OBTAINING ALL NECESSARY PERMITS AND APPROVALS.

1-800-BOLLARDS

The Bollard Experts

REVISIONS			
LTR	DESCRIPTION	DATE	APP'VD
COMMENTS			
SPECIFICATIONS			
HEIGHT: 36"			
DIAMETER: 6.625"			
WALL THICKNESS: 0.280"			

- SELECT DESIRED MATERIAL:
(6" NOMINAL SIZE)
 - FCSCT06040 SCH 40 STAINLESS STEEL
 - FCSCT06040 SCH 40 ASTM A-53 CARBON STEEL
- SELECT DESIRED STAINLESS STEEL BOLLARD FINISH:
 - POLISHED #4 FINISH
 - AS SPECIFIED _____
- SELECT DESIRED CARBON STEEL BOLLARD FINISH:
 - POWDERCOAL RAL # _____
 - AS SPECIFIED _____
- SELECT DESIRED STAINLESS STEEL BOLLARD MATERIAL:
 - TYPE 304
 - TYPE 316
- SELECT DESIRED BOLLARD CAP STYLE:
 -  DOME (SHOWN)
 -  STANDARD FLAT
 -  SLOPED
- LENS SELECTION
 - CLEAR 
 - FROSTED 
 - INTERNAL FROSTED 
 - PARACLINE SILVER 
 - PARACLINE WHITE 
 - LOUVER GREY 
 - LOUVER WHITE 
- WATTAGE
 - 5W 16LEDS 100mA
 - 8W 16LEDS 175mA
 - 12W 16LEDS 250mA
- CCT
 - COOL
 - NEUTRAL
 - WARM
- VOLTAGE
 - 120-277VAC
 - 120V

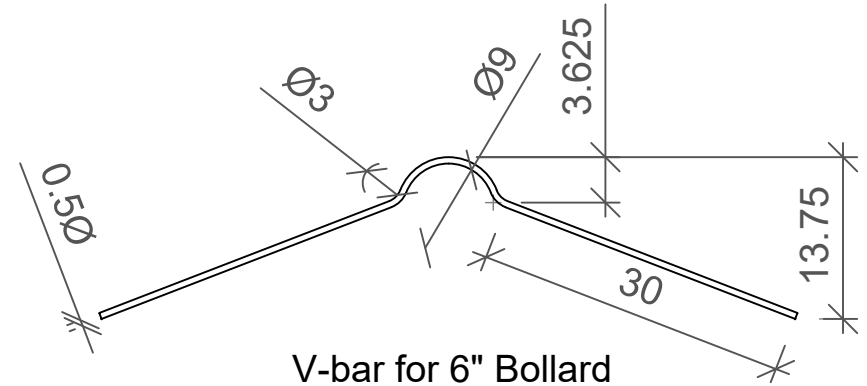
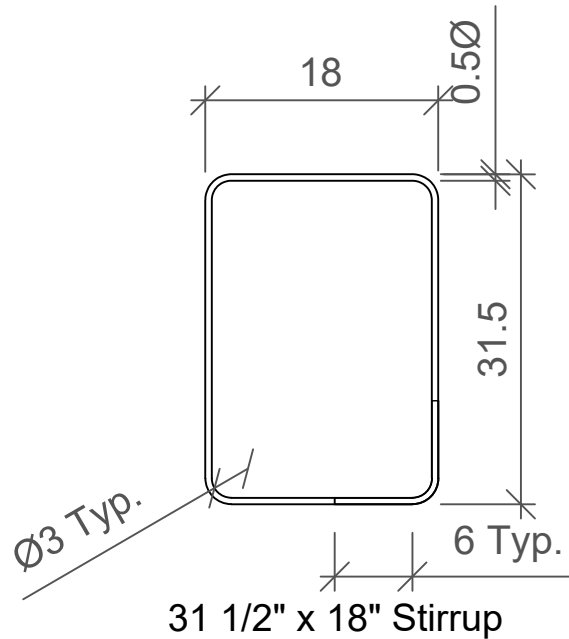

V-bar for 6" Bollard

DOME (SHOWN) STANDARD FLAT SLOPED



APPLICATION		SERIES NUMBER: XX-S060-XX		CAGE CODE	SIZE	DRAWING NUMBER:
NEXT ASSY	USED ON	PRODUCT FAMILY:	20 MPH CRASH TESTED	6NGJ8	6"	6" CT FIXED
		PRODUCT CLASS:	STANDARD OR CUSTOMER DEFINED		AJA	DRAWING REV:
		PRODUCT LINE:	BOLLARD	CHECKED BY:		SHEET 1 OF 1
		PRODUCT SUB LINE:	FIXED	APPROVED BY:		RELEASE DATE:
		1-800-BOLLARDS, Inc. 10 Hughes Sutter A105 Irvine, CA 92618 PHONE: 1-800-BOLLARDS WEB: WWW.1800BOLLARDS.COM EMAIL: INFO@1800BOLLARDS.COM		TITLE: BOLLARD, CT FIXED		

1. INSTALLATION TO BE COMPLETED IN ACCORDANCE WITH MANUFACTURER'S SPECIFICATIONS.
2. DO NOT SCALE DRAWING.
3. THE OPERATIONS INTENDED FOR USE BY ARCHITECTS, ENGINEERS, CONTRACTORS, CONSULTANTS AND DESIGN PROFESSIONALS FOR PLANNING PURPOSES ONLY. THIS DRAWING IS NOT TO BE USED FOR CONSTRUCTION.
4. ALL DIMENSIONS UNLESS OTHERWISE STATED ARE IN INCHES AND DECIMALS THEREOF. DIMENSIONS IN PARENTHESES ARE FOR INFORMATION ONLY AND SHOULD BE REVIEWED AND APPROVED BY THE PRODUCT MANUFACTURER TO BE CONSIDERED ACCURATE.